

PREVIEW

KODEN

4.3-inch Color LCD
Remote Display

KRD-10



Screen image: Wind Direction

Various type of NMEA sentence data from GPS Compass, Weather station, Wind anemometer, Rudder sensor etc. can be displayed

Features

- ▶ Numeric keypad mounted
- ▶ Selectable screen display from 18 different modes

< Screen Image >

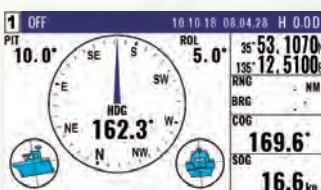

Compass

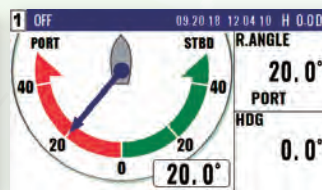

Rudder Angle

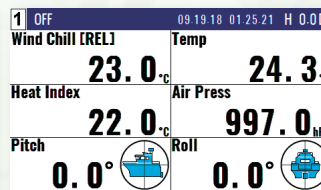

Weather Info

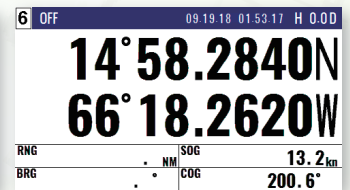

Navigation

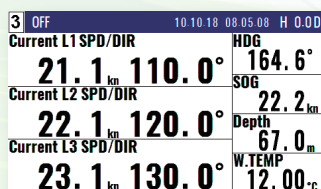

Current

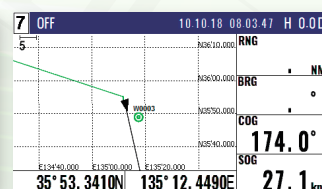

Plotter

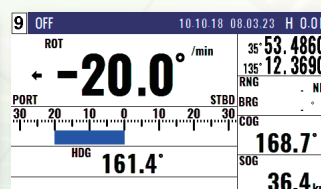

ROT

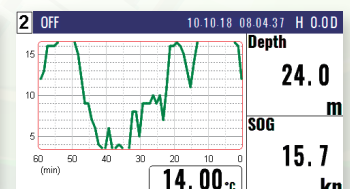

Water Temperature

SPECIFICATIONS

Model	KRD-10
Display size and type	4.3 inch color LCD (480x272, effective picture area: 95.04 x 53.86 mm)
Presentation modes	Navigation, Steering, Highway, Plotter, Compass, Turnaround, Wind direction, Water temp, Rudder angle, Distance to, General, Tide current, Weather info, Water temp
Track display	Display range: 0.025, 0.05, 0.1, 0.2, 0.5, 1, 2, 5, 10, 20 nm (sm, km) Usable ground: Within 80° in latitude Plotting interval: 5, 10, 20, 30 seconds, 1 minutes, 0.01, 0.05, 0.1, 0.5, 1 nm (sm, km) Plotting capacity: 3,000 points
Position data display	Latitude / Longitude in increments of 0.0001 minute, Converted Loran CLOPs, Converted Loran A LOPs, Converted Decca LOPs
Navigational display	Speed, Course, Distance / Bearing to waypoint, Crosstrack error, Time to go to waypoint, Total time to go and distance on route, DOP value, Present time (UTC or LTC), Satellite status, Beacon receiving status, Distance / Bearing between two points, PCB display
Instant (event) memory	1,000 points
Waypoint memory	10,000 points (9,000 + Event 1,000)
Route memory	100 routes reverse trail possible
Alarms	Proximity, Cross track error, CDI, Anchor watch
Position compensation	Latitude / Longitude, LOPs, Datum
Magnetic compensation	Auto or Manual
Parameters	Loran CLOPs conversion, Loran A LOPs conversion, Decca LOPs conversion, Memory of waypoints and name (up to 10 letters), Selection of measuring unit (nm, sm, km), Averaging (smooth) factor
Output data format and sentences (DATA1/2 connector)	NMEA 0183 Ver.1.5 / 2.0 / 3.0 AAM, APB, BOD, BWC, CUR, DBT, DCN, DPT, DTM, GBS, GGA, GLC, GNS, GSA, GSV, HEV, HDG, HDT, HDM, HPR, MDA, MSS, MTW, MWD, MWV, RMC, RMB, RMC, ROT, RSA, RTE, VDR, VHW, VLW, VTG, WDC, WPL, XDR, XTE, ZDA, ZDL
Input data format and sentences	NMEA 0183 Ver.1.5 / 2.0 / 3.0 AAM, APB, BOD, BWC, DCN, DPT, DTM, GGA, GLC, GSA, GSV, HEV, HDT, HDM, HPR, MSS, MTW, MWV, RMC, RMB, RMC, ROT, RTE, VHW, VTG, WDC, WPL, XTE, ZDA
NMEA ports	Total 2 : input 1 / output 1
Power supply	10.8 to 31.2 V DC
Power consumption	4.5 W or less (24V DC)

Note: Accuracy is subject to change in accordance with DoD civil GNSS user policy.

Environmental

Operating temperature	-15 °C to +55 °C
Water protection	IPX4

CONNECTIONS

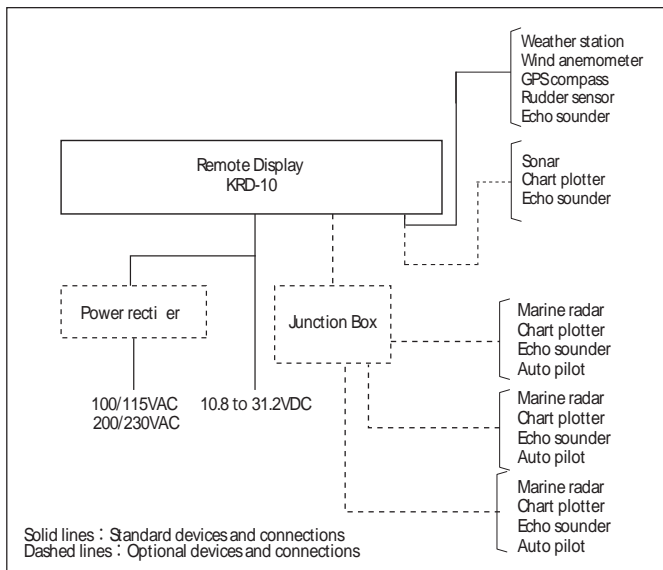

EQUIPMENT LIST

Standard Equipment

Remote Display	KRD-10	Mounting bracket, GPS connector protection cap, with hard cover
Connecting cable	OW-376-5M	With 6-pin connector and one end plain (5m)
DC power cable	OW-276-2M	With 5-pin connector and one end plain (2m)
Operation Manual		

Options

Connecting cable, Junction box, Power rectifier, AC power cable

DIMENSIONS AND WEIGHT

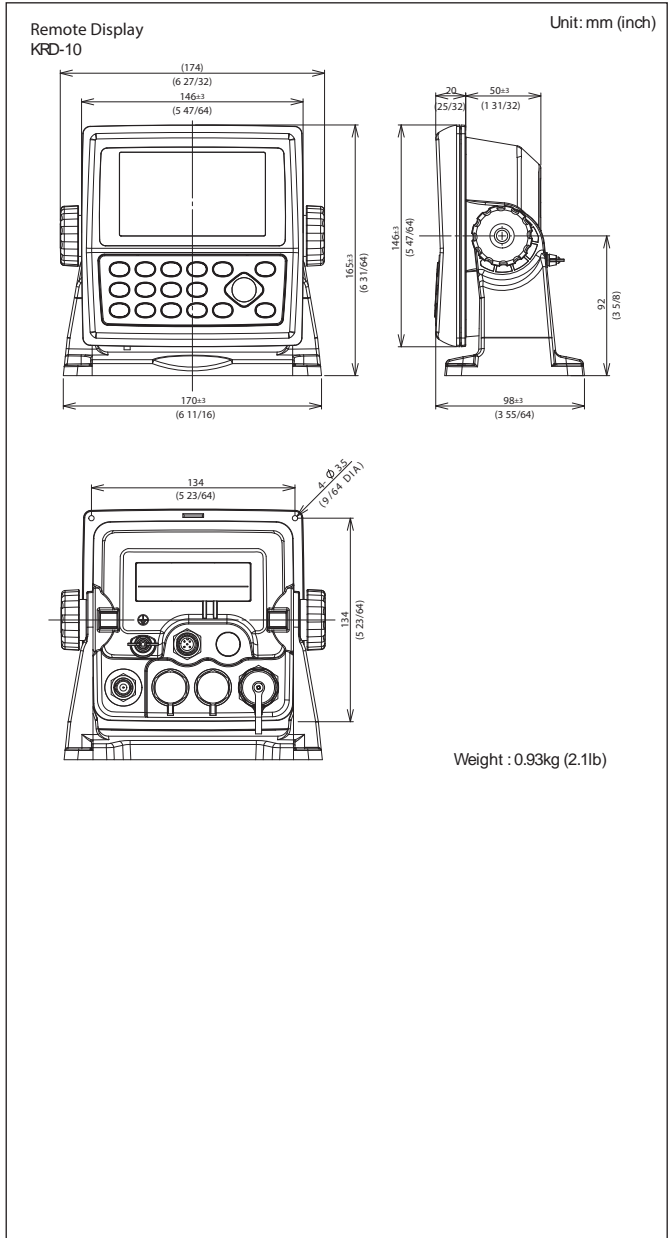

• Design and specifications are subject to change without notice.

KODEN Kodon Electronics Co., Ltd.

Tamagawa Office:
2-13-24 Tamagawa, Ota-ku, Tokyo, 146-0095 Japan
Tel: +81-3-3756-6501 Fax: +81-3-3756-6509
Uenohara Office:
5278 Uenohara, Uenohara-shi, Yamanashi, 409-0112 Japan
Tel: +81-554-20-5860 Fax: +81-554-20-5875

overseas@koden-electronics.co.jp

www.koden-electronics.co.jp



Safety precaution

To ensure proper and safe use of the equipment, please carefully read and follow the instructions in the Operation Manual.

For details, please contact: